

Pendant light 40 x 10

GERA Light system 6

www.gera-leuchten.de

Technical information 06.2015

Light connection	left/center/right, directly onto the connecting terminal
Light length	minimum 900 mm maximum 4000 mm
Length of suspension cable:	adjustable from 0.2 m – 2.5 m
Acrylic cover	curtailed delivery of acrylic cover due to heat expansion
Materials	anodised aluminium coloured anodised stainless steel coloured anodised brown-black coloured dimnable (Touch Dim) only possible using 5-pole supply alternatively dimmable using sensor switch

Nominal voltage	230 V, 50 – 60 Hz
Illuminant	LED
Light colour	3000 K (warm white) 4000 K (neutral white)
Brightness	1200 lm/m
Power	19 W/m
Energy efficiency class	A+
Protection class	⬇
Protection type	IP 20

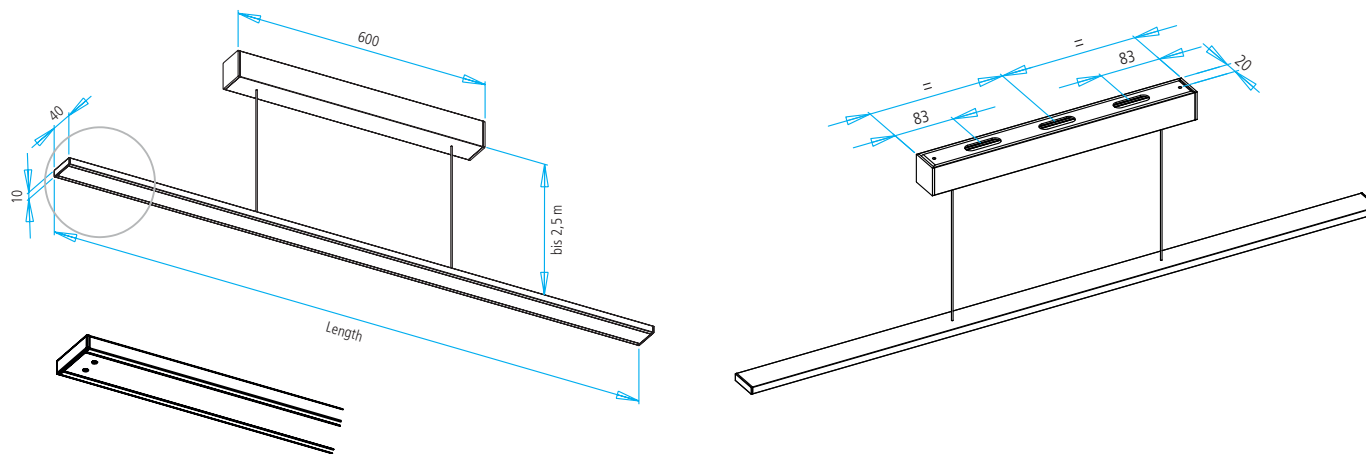

Version with sensor switch

Dimensions in mm